



SPECIFICATIONS

SS-100NH-V300* CC DRIVER

Model: SS-100NH-V300*

Power: 100W

Rev.: V04

Release date: 2026-02-25

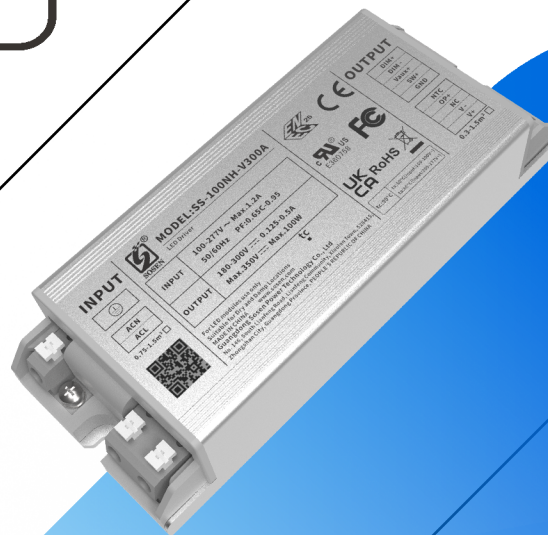

SS-100NH-V300* LED DRIVER

Features

- Efficiency up to 97%
- Isolated dimming:0-10V,PWM,Resistor
- Optional aux: 12V/0.2A
- Time-controlled programmable
- Dim to off
- Standby Power<0.5W
- Protections: SCP/OTP/OVP/UVP
- Compatible with intelligent emergency controls
- Wide output voltage range
- NTC, Optical, Dial Power Range Programmable
- Surge protection: CM: 6kV,DM: 6kV
- Long lifetime
- Warranty: 5 years



Description

SS-100NH-V300* series are 100W non-isolated constant current LED Driver with 90-305VAC. It has DIM to Off, high efficiency, isolated auxiliary power supply, Compatible with intelligent emergency controls,compact housing ,fullypotted , high reliability, high cost performance and other advantages.

Applications:

Shoobox Light, Linear high bay light, Flood lighting, Wall lamp

Model List

Model	AC Input Range	Max. Pout	Vout Range	Recommended Voltage	Iout Range	Default Current	THD (Typ.)	PF (Typ.)	Eff. (Typ.)	Max.Tc
SS-100NH-V300*	90-305Vac	100W	180-300V	260V-300V	0.125-0.5A	0.4A	8%	0.97	97%	90°C

Note:

1.Default Tested: at 220Vac, full load, Ta 25°C.

2.The performance of the LED Driver can be guaranteed within the full power Vo range.The voltage lower than full power Vo range,it is need to test the performance with the LED module.

SS-100NH-V300* LED DRIVER

“*” Means Additional Function

“*”	AUX 12V (suffix:H)	Dimming off 0-10V/PWM/Resistor	1-10V/PWM Resistor(suffix:B)	adjust power (Single DIP)	Photosensitive control	NTC	Remark
A	✓	✓		✓	✓	✓	
BB			✓	✓			
BHB	✓	✓		✓			

Input Characteristics:

Parameter	Min.	Typ.	Max.	Remark
Rated AC Input Range	100Vac		200Vac	≤Ta: 50°C (conditioned use) 108V or less
	200Vac		277Vac	Ta:60°C (conditioned use)
AC Input Range	90Vac		305Vac	Reference derating curve
Input DC Voltage Range	140Vdc		280Vdc	(A, BHB models)
Input Frequency Range	47Hz	50/60Hz	63Hz	
Max Input Current			1.2A	100Vac, Full load
Max Input Power			120W	100Vac, Full load
Max Inrush Current(120Vac)			40A	Cold start
Max Inrush Current(220Vac)			80A	Cold start
Max Inrush Current(277Vac)			115A	Cold start
Standby Power			0.5W	220Vac/50Hz, Dim-to-off (A/BHB models)
Power Factor	0.95	0.97		220Vac, Full load
	0.90			100-277Vac, 70%-100% load
THD		8%	12%	220Vac, Full load
			20%	100-277Vac,70%-100% load

SS-100NH-V300* LED DRIVER

Output Characteristics

Parameter	Min.	Typ.	Max.	Remark
O/P Voltage Range	180V		300V	Power derated @180-200V
Rated O/P Voltage	200V		300V	Po=Vo*Io=100W, Full load
Rated O/P Current	0.33A		0.5A	0.5A for 200V,0.33A for 300V
Adj. O/P Current (AOC)Range	0.125A		0.5A	
No Load Voltage			350V	
Efficiency @120Vac	92.0%	94.0%		Output 300V/0.33A
Efficiency @220Vac	94.0%	96.0%		Output 300V/0.33A
Efficiency @277Vac	95.0%	97.0%		Output 300V/0.33A
O/P Current Tolerance	-5%		+5%	
O/P Current Ripple(PK-AV)		5%	10%	Full load
Start-up Current Overshoot			10%	Full load
Start-up Time			1.0S	120Vac,Full load
			0.75S	220Vac,Full load
Line Regulation	-5%		+5%	Full load
Load Regulation	-5%		+5%	
Temperature Coefficient	-0.06%/°C		+0.06%/°C	Tc:0°C~90°C
OTP	90°C	95°C	100°C	Drop current when OTP, and it can be automatically restored after the abnormality is removed.
Short Circuit Protection				Driver will not be damaged Constant current mode or hiccups

SS-100NH-V300* LED DRIVER

Output Characteristics

Parameter		Min.	Typ.	Max.	Remark
Aux Power (A/BHB models)	O/P Voltage	10.8V	12V	13.2V	
	O/P Current			200mA	
0-10V Dimming (Optional A/BHB models)	Dim Vmax	0V		12V	DIM+ source current 110uA.
	Dim Range	10%Iomax		100%Ioset	Dimming prohibits reverse connection
	Rec.Dim Range	0V		10V	
PWM Dimming (Optional A/BHB models)	PWM High	9.8V		10.2V	DIM+ source current 110uA.
	PWM Low	0V		0.3V	Dimming prohibits reverse connection
	Frequency	1KHz		2KHz	
	PWM Duty	0%		100%	
Resistor Dimming (Optional A/BHB models)	Resistance	0Kohm		100Kohm	DIM+ source current 110uA.
	Dim Range	10%Iomax		100%Ioset	
Dim to Off (A/BHB models)	Dim off	0.7V	0.8V	0.9V	Auxiliary source 12V unloaded
	Dim on	0.9V	1.0V	1.1V	
Dial adjustment	Current range	0.132A		0.5A	Dialing range can be set via PC software
Default light control (A/BHB models)	Shutdown Voltage	0V	1.0V	1.2V	Default: 5S action; time/voltage on, off can be set by PC software
	Turn-On Voltage	3.2V	3.5V	5.0V	
Intelligent Emergency Control (Optional, off by default A/BHB models)	Emergency switchover time	3S			AC power failure switching to battery power supply time
	Output Current		8%	10%	Emergency output current can be set via PC software
	Auto-exit time			3H	When the sensor does not detect a signal configurable
	Access to emergency communications	4Hz duty cycle 25%, high level: 4-10V, low level: 0-0.3V			Duration 30S
	Withdrawal from emergency communications	1Hz duty cycle 25%, high level: 4-10V, low level: 0-0.3V			Duration 3H; configurable
Timing Curve(Optional A/BHB models)	By programming			Set by program	

SS-100NH-V300* LED DRIVER

Output Characteristics

Parameter	Min.	Typ.	Max.	Remark	
1-10V Dimming (Optional, BB models)	Dim Vmax	0V		12V	DIM+ source current 110uA.
	Dim Range	10%Iomax		100%Ioset	Dimming prohibits reverse connection
	Rec.Dim Range	1V		10V	
PWM Dimming (Optional, BB models)	PWM High	9.8V		10.2V	DIM+ source current 110uA.
	PWM Low	0V		0.3V	Dimming prohibits reverse connection
	Frequency	1KHz		2KHz	
	PWM Duty	10%		100%	
Resistor Dimming (Optional, BB models)	Resistance	10Kohm		100Kohm	DIM+ source current 110uA.
	Dim Range	10%Iomax		100%Ioset	
Dial adjustment	Current range	0.132A		0.5A	Dialing range can be set via PC software
Lifetime(Tc≤85°C)	≥50,000 hours			80% load	
MTBF	200,150 hours			220Vac, Full load, Ta=25°C (MIL-HDBK-217F)	
Tc	90°C				
Warranty	5 years			Tc 85°C	
Net Weight	420g				
Dimension	138mm*55mm*32mm			L x W x H	

NOTE: All the parameters above are tested Ta 25°C and LED load, unless specified.

SS-100NH-V300* LED DRIVER

Environmental Requirements

Parameter	Min.	Typ.	Max.	Remark
Operating Temperature(Tcase)	-40°C	25°C	+90°C	
Storage Temperature	-40°C	25°C	+90°C	
Operation Humidity	10%RH		90%RH	
Storage Humidity	5%RH		95%RH	
Altitude	-65m		4000m	

Safety and EMI/EMS Standards

Certification	Standard	Status	Remark
UL/cUL	UL8750	✓	
ENEC	EN 61347-1 EN 61347-2-13 EN IEC 62384	✓	
RCM	AS/NZS61347.2.13	✓	
BIS	IS15885		
CCC	GB/T 19510.1 GB/T 19510.213	✓	
CE	EN 61347-2-13 EN61347-1	✓	

EMI/EMS	Criterion	Remark
Conduction Emission	FCC Part15: Subpart B ANSI 63.4	120Vac,277Vac:Class B
	EN IEC 55015	230Vac
Radiation Emission	FCC Part15: Subpart B ANSI 63.4	120Vac,277Vac:Class B
	EN IEC 55015	230Vac
Harmonic Current Emissions	IEC/EN 61000-3-2	Class C
Surge	IEC/EN61000-4-5	DM: 6kV,CM: 6kV,Criterion B
Ring Wave	IEC/EN61000-4-12	DM: 6kV,CM: 6kV,Criterion B

SS-100NH-V300* LED DRIVER

IEC (Intelligent Emergency Control) Description:

Connection Diagram

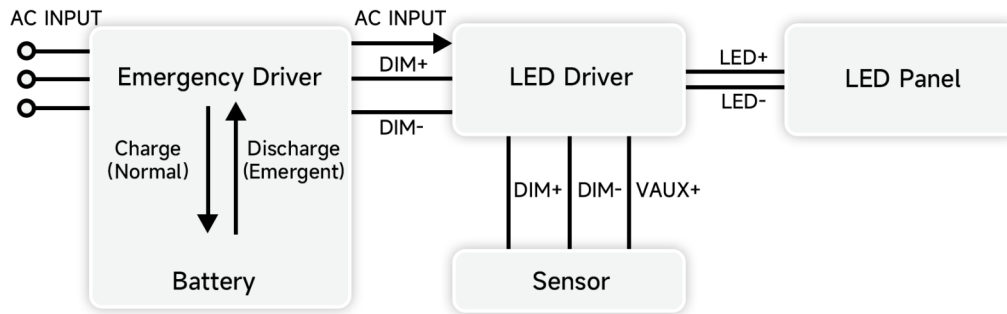

Emergency control logical diagram

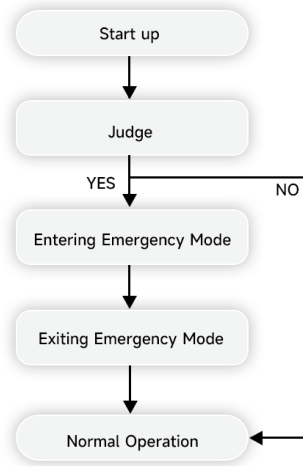

Technical Specifications for Emergency Lighting Communication Protocol

- (1) Definition of Communication Levels: Active High Level: 4V - 10V (ON); Active Low Level: 0V - 0.3V (OFF).
- (2) Positive Duty Cycle of Communication Signal: 25%.
- (3) Entering Emergency Mode: The emergency driver supply will send a signal with 4Hz and a duty cycle of 25% after entering the emergency state. The LED driver supply must continuously detect this signal four times (signal duration of 30 seconds) before entering the emergency mode.
- (4) Exiting Emergency Mode:
 - Scenario 1: Upon restoration of AC driver, the emergency driver supply sends a signal with 1Hz and a duty cycle of 25%. The LED driver supply must continuously detect this signal four times to exit the emergency mode.
 - Scenario 2: If it's timeout in the emergency state, the LED driver supply automatically exits the emergency mode after a default period of 3 hours can be set.

Notes:
In the absence of a detected signal from the sensor (dimming line is a short circuit), the LED driver supply automatically exits the emergency mode after 3 hours. To ensure timely exit from the emergency mode, upon sensor signal detection (releasing the short circuit on the dimming line), the emergency driver supply continues to send the 1Hz exit signal for 3 hours after detecting the restoration of AC driver.
The LED driver supply is equipped with an emergency function switch that can be enabled through our proprietary PC software (default setting is "off"). For obtaining relevant emergency certifications, compatibility with the emergency driver supply system during certification is required.
When the emergency function is used, and the system is operating under no-load conditions or with the "Dim-off" function enabled, the system should delay switching to battery for 15 seconds after AC power loss.

SS-100NH-V300* LED DRIVER

Safety Test Items

Safety Test Items	Technical Indicators			Remark
Insulation Requirements	UL Insulation Requirements	ENEC Insulation Requirements	CCC Insulation Requirements	
Input-Case	2U+1000Vac	2U+1000Vac	2U+1000Vac	Basic insulation
Input-Dim	2U+1000Vac	4U+2000Vac	4U+2000Vac	Reinforced insulation
Dim-Case	500Vac	500Vac	500Vac	Basic insulation
Insulation Resistance	≥10MΩ			Input-Dim, Test voltage:500Vdc
Ground Resistance	≤0.1Ω			25A/1min
Leakage Current	≤0.75mA			277Vac

NOTE:

1. SOSEN warrants the LED Driver itself complies with EMC standard. However, LED Driver's EMC should be re-checked when integrated into lighting systems due to unexpected interference of components.
2. For voltage withstand test, short-circuit between L/N, short-circuit between output line positive/negative, short-circuit between dimmer line and VPP or between dimmer line and auxiliary source positive/negative.

Performance Curves

Input Inrush Current

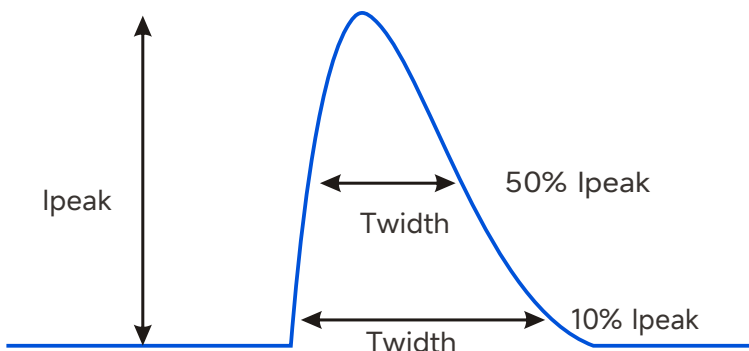

Vin	Ipeak	T(@10% of Ipeak)	T(@50% of Ipeak)
120Vac	40A	350uS	150uS
220Vac	80A	350uS	150uS
277Vac	115A	350uS	150uS

SS-100NH-V300* LED DRIVER

Performance Curves

Output Voltage Vs. Output Current(Dim/AOC Window)

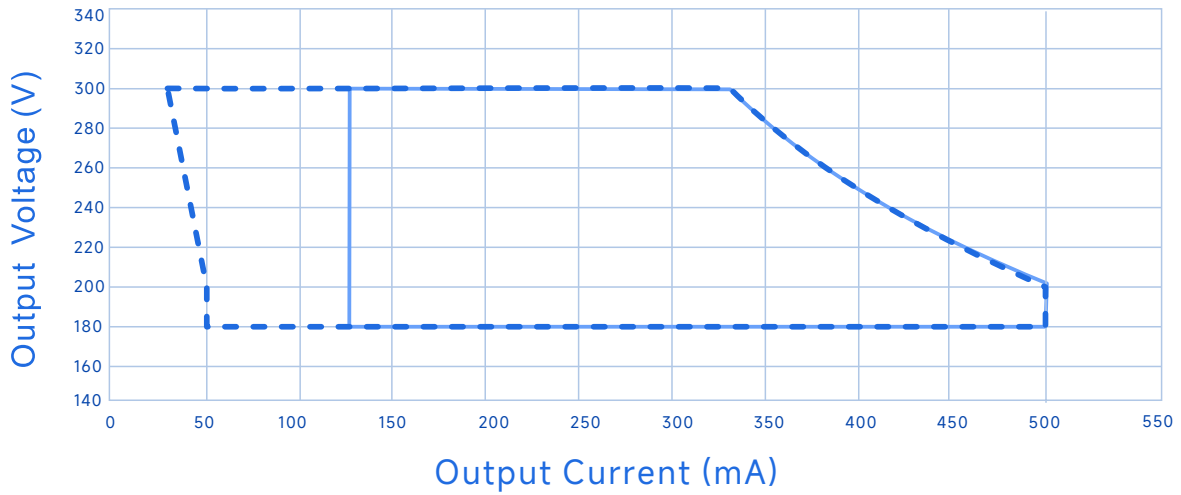

----- Dimming Window ————— AOC Window

Efficiency Vs. Output Voltage (Vin=120Vac)

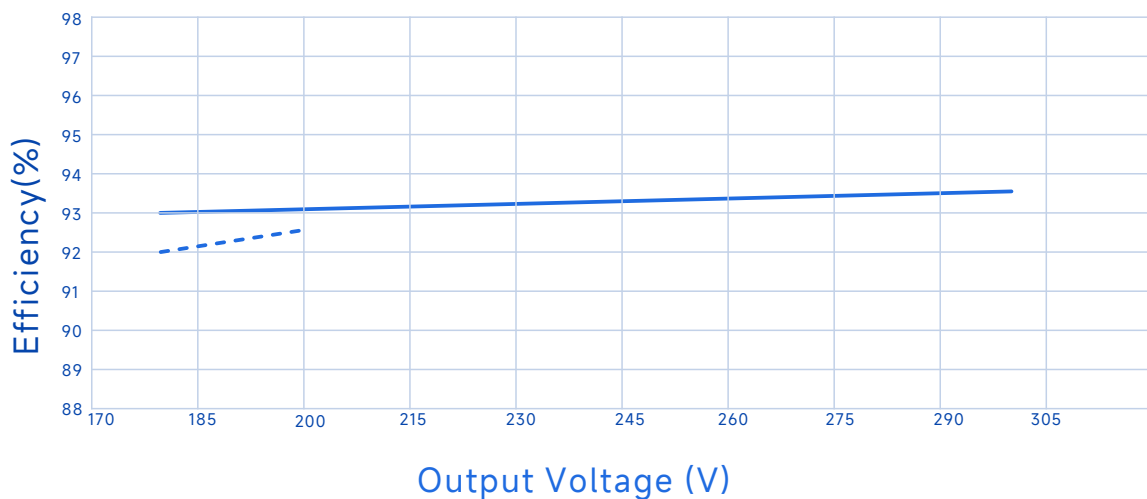

----- Io=500mA ————— Io=330mA

SS-100NH-V300* LED DRIVER

Performance Curves

Efficiency Vs. Output Voltage ($V_{in}=220V_{ac}$)

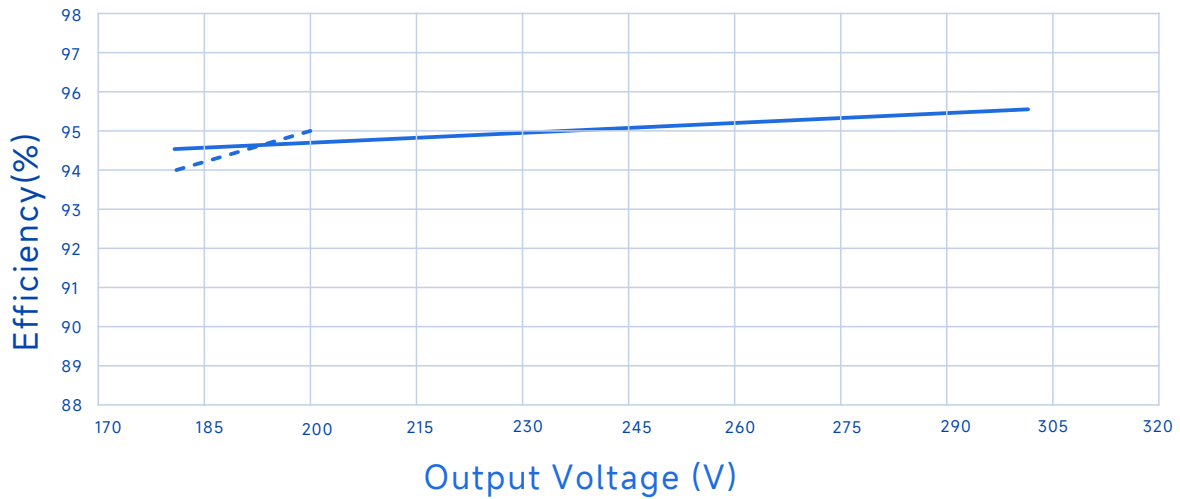

----- $I_o=500mA$

————— $I_o=330mA$

Efficiency Vs. Output Voltage ($V_{in}=277V_{ac}$)

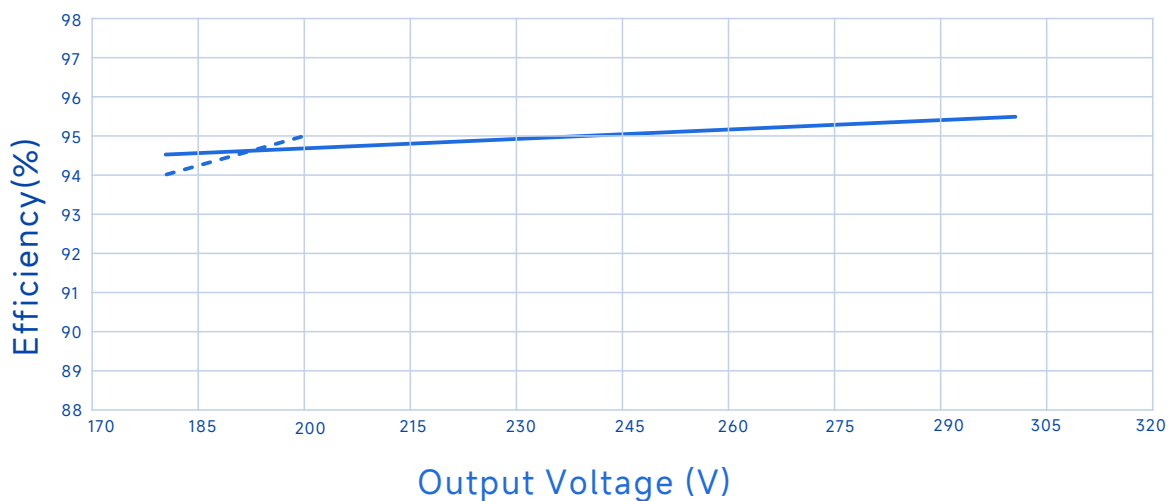

----- $I_o=500mA$

————— $I_o=330mA$

SS-100NH-V300* LED DRIVER

Performance Curves

Power Factor Vs. Output Power

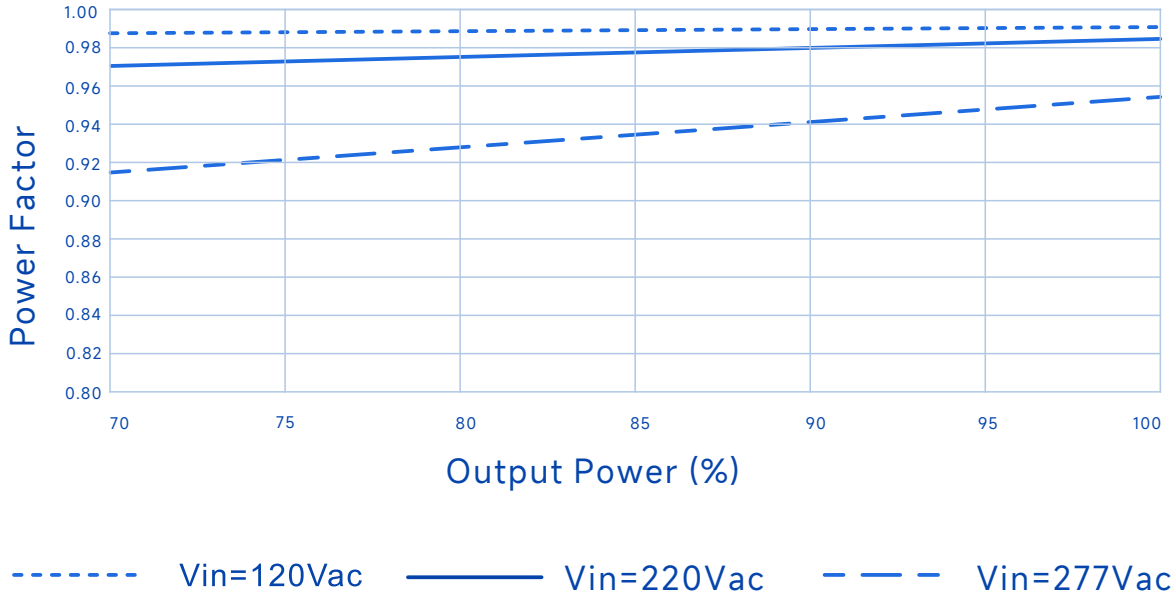

THD Vs. Output Power

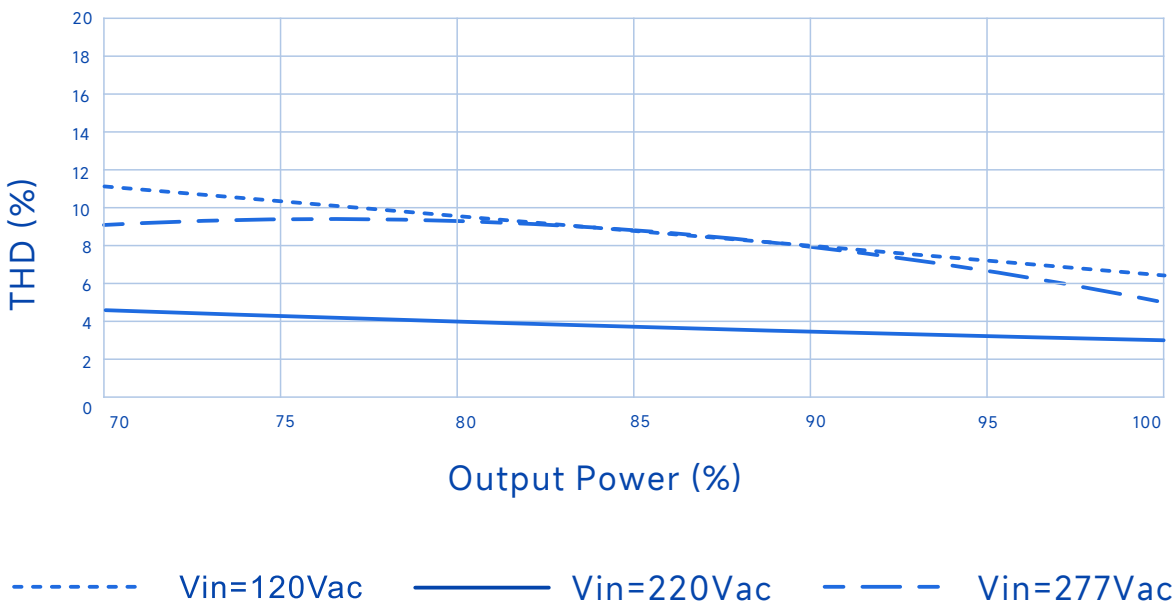

SS-100NH-V300* LED DRIVER

Performance Curves

Output Power Vs. Input Voltage

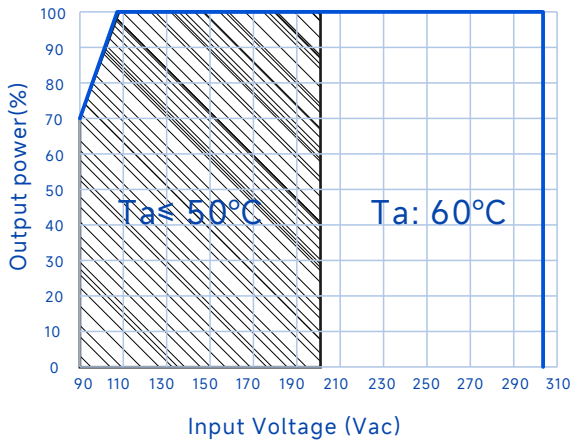

Output Power Vs. Case Temperature

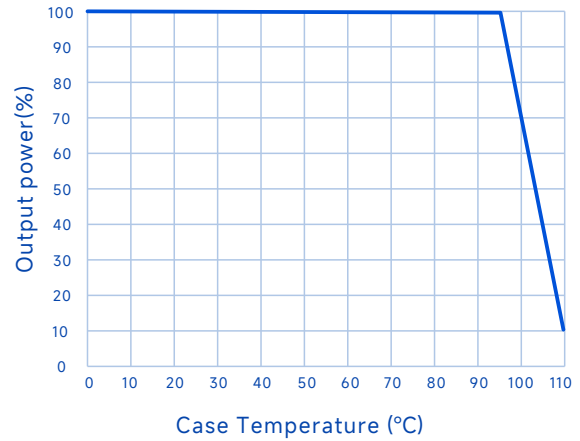

Output Power Vs. Dimming (A/BHB models)

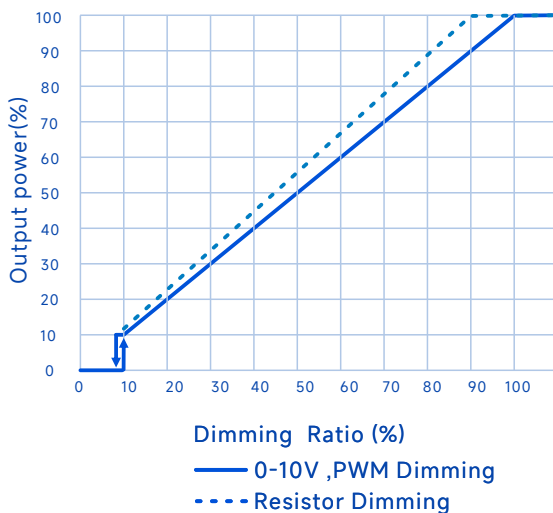

Output Power Vs. Dimming (BB models)

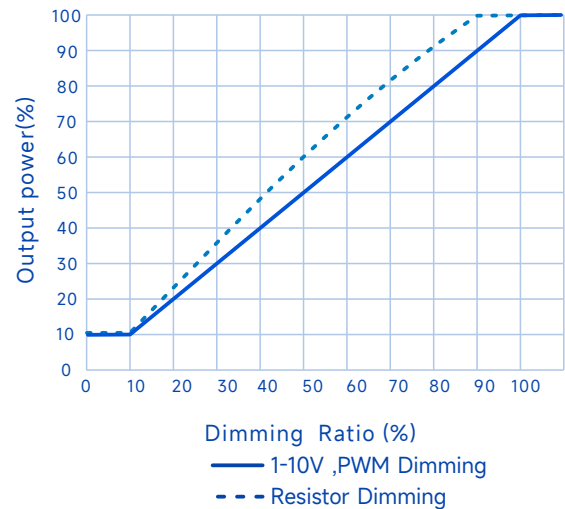

SS-100NH-V300* LED DRIVER

Performance Curves

Lifetime Vs. Case Temperature

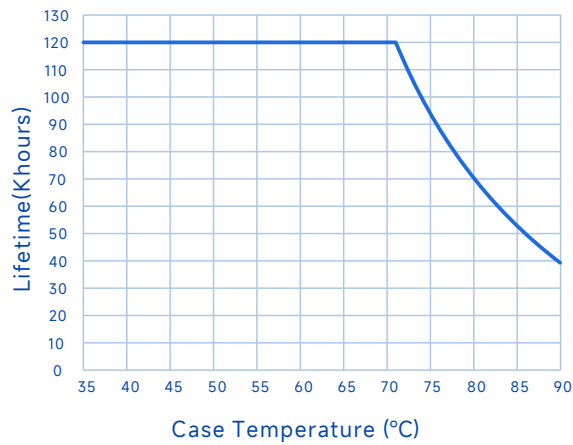

SS-100NH-V300* LED DRIVER

Programming connection diagram

Legacy Timer: Driver's O/P follows the pre-programmed timing curve after turn-on.
Auto-Adjust by Percentage: Driver's O/P will be adjusted by automatically changed dimming curve by the period percentage based on the latest 5 dimming curve.
Auto-Adjust by Mid-point: Driver's O/P will be adjusted by automatically changed dimming curve by mid-point based on the latest 5 dimming curve.

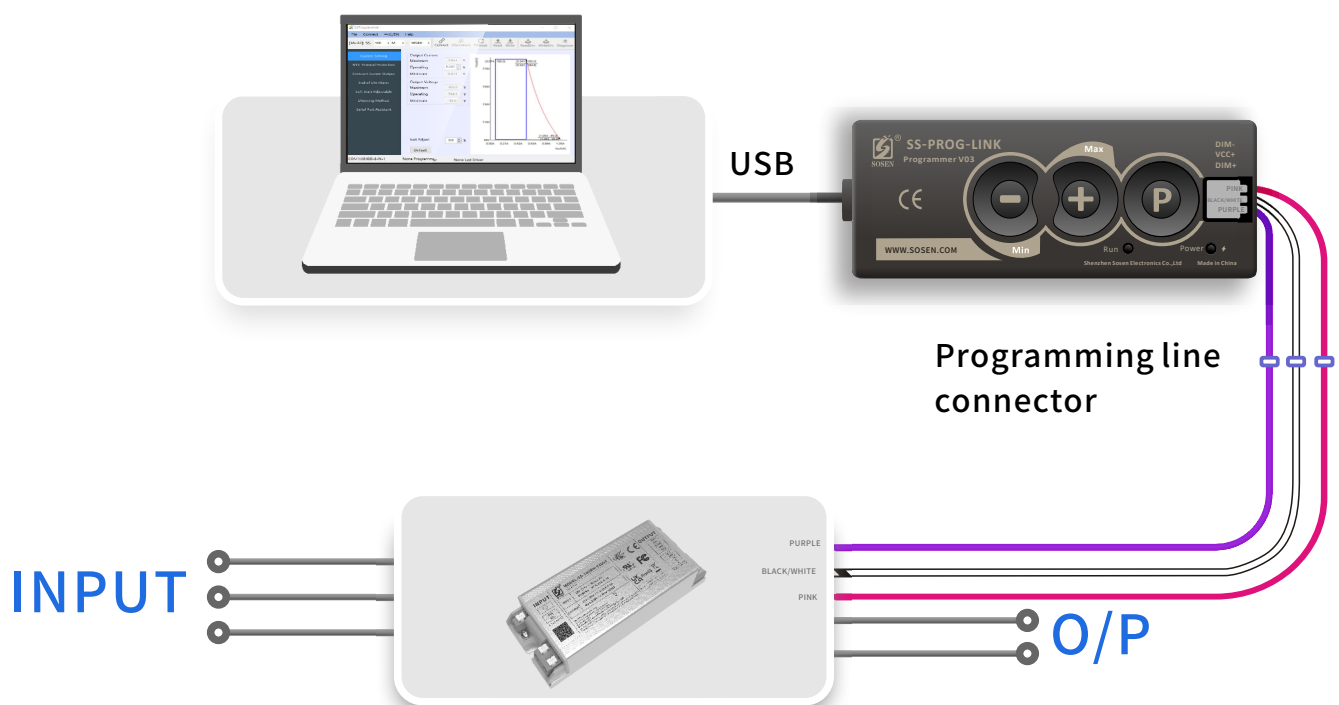

Note:

For details, please refer to the Sosen SS-PROG-LINK Programmer Manual.

SS-100NH-V300* LED DRIVER

Mechanical Characteristic

A,BHB models

AC Input Terminal
ACL: connect to L wire, ACN: connect to N wire,
⊕: connect to earth wire

DC Input Terminal
V+: light source board positive, V-: light source board negative

Function Terminal
DIM+:Dimming Positive, DIM-:Dimming Negative, VAUX+:Auxiliary Source, SW+:Dialing Power, GND:Negative, NTC:LED Over-temperature Protection, OP+:Light Sensing Function

BB models

AC Input Terminal
ACL: connect to L wire, ACN: connect to N wire,
⊕: connect to earth wire

DC Input Terminal
V+: light source board positive, V-: light source board negative

Function Terminal
DIM+:Dimming Positive, DIM-:Dimming Negative, SW+: power dialing, GND: negative, VPP+: offline burning power supply

SS-100NH-V300* LED DRIVER

Mechanical Characteristic

Name Description	Standard Code	mm(In.)
Case Width	W1	55(2.165)
Mounting Hole Width	W2	27.5(1.083)
Overall Length	L1	138(5.433)
Mounting Hole Length	L2	130(5.118)
Case Length	L3	111(4.370)
Case Height	H	32(1.259)
TC Point Position	X	65(2.559)
TC Point Position	Y	17(0.669)

Note

1, Please follow the "LED Driver User Manual" obtained from SOSEN's official website for assembly.

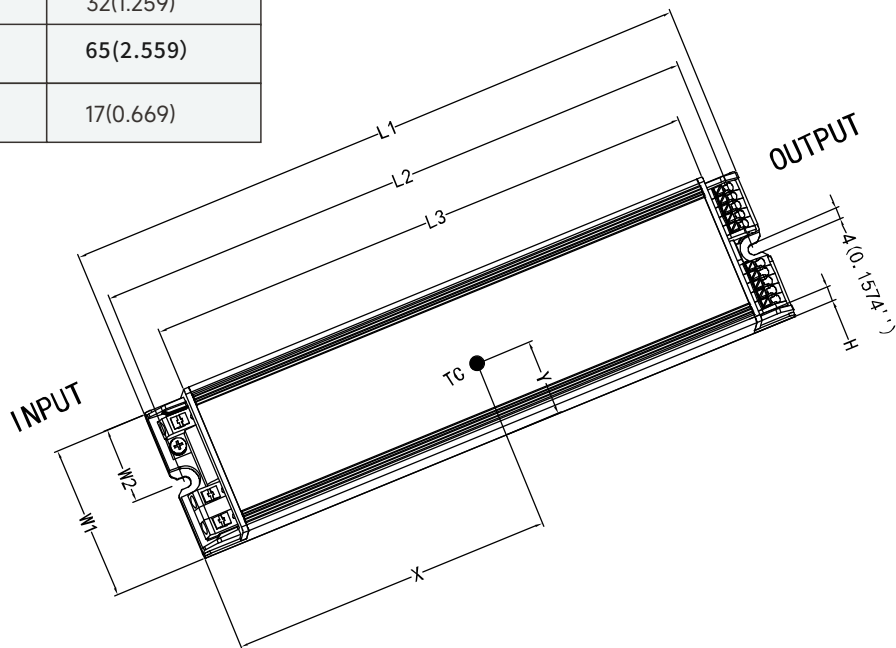

SS-100NH-V300* LED DRIVER



Assembly Tips

1. The trace routing on aluminum substrates is designed in compliance with creepage distance requirements specified by relevant certification regulations.
2. The creepage distance between LED+ and LED- on the aluminum substrate is designed in compliance with the relevant certification regulations.
3. Minimize the copper area on the aluminum PCB to reduce parasitic capacitance and leakage current.
4. It is recommended to design LED beads in parallel first and then in series.
5. The insulation level of LED light panels should meet the reliability design requirements.
6. It is recommended not to exceed the parameters used in the specification, otherwise it may lead to a higher risk of power supply reliability.
7. For other precautions, please refer to the "LED Driver User Manual".
8. SOSEN reserves the right of final interpretation of the above parameters.

Warning

Insufficient or compromised insulation voltage resistance in LED light panels may cause breakdown and short circuits to earth, resulting in damage to the luminaire and LED driver, and posing significant safety hazards. It is recommended to install a residual current device (RCD) during application.

Package

- Outside carton dimension: L×W×H = 325mm×315mm×165mm;
- 40PCS/Carton;
- Net weight/Piece: 0.42kg; Gross weight/Carton: 17.8kg;
- Please refer to the product name, model number, manufacturer identification, QC PASS, manufacturing date on the package.

Transportation

Packaging is designed suitable for transportation by trucks, vessels and flights. The products should be avoided direct sunlight and rain, loaded/unloaded with caution.

Storage

The product storage meets the standard of the GB 3873-83.
Products should be rechecked if stored for over 1 year before assembly.

RoHS

Products comply with RoHS Directive (2011/65/EU) and amendment 2015/863/EU.

Revision History

Version	Description of Update	Updated Date	Remark
V00	Original Release	2024/09/08	
V01	Updated intelligent emergency controls	2024/11/23	
V02	Increase in BB models	2025/06/24	
V03	Updated safety standards	2025/07/15	
V04	Add a warning notice	2026/02/25	